



5894

5894

TWIN BEAM POWER TUBE

Useful at Frequencies up to 500 Mc

Unless Otherwise Specified, Values are on a Per-Tube Basis

GENERAL DATA

Electrical:

Heater for Unipotential Cathode:

Heater arrangement	Series	Parallel	
Voltage	12.6 ± 10%	6.3 ± 10%	ac or dc volts
Current	0.9	1.8	amp

Mu-Factor, Grid No.2 to
(Grid No.1 (Each Unit)
for dc plate volts = 600
dc grid-No.2 volts = 250,
and dc plate ma = 40

8.2

Direct Interelectrode Capacitances (Each Unit):^o

Grid No.1 to plate.	0.8 max.	μf
Grid No.1 to cathode & grid No.3 & internal shield, grid No.2, and heater.	11	μf
Plate to cathode & grid No.3 & internal shield, grid No.2, and heater.	3.4	μf

Mechanical:

Mounting Position:

Vertical Base up or down
Horizontal Plate terminals in horizontal plane

Maximum Overall Length	4-5/16"
Seated Length.	3-11/16" ± 3/16"
Maximum Diameter	1-15/16"
Bulb	T-14
Bulb Terminals (Two)	See Dimensional Outline
Weight (Approx.)	2.3 oz
Base	Small-Wafer Septar 7-Pin (JETEC No.E7-21)

BOTTOM VIEW

- Pin 1 - Heater
- Pin 2 - Grid No.1 of Unit No.2
- Pin 3 - Grid No.2
- Pin 4 - Cathode, Grid No.3, Internal Shield

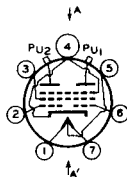

- Pin 5 - Heater Mid-Tap
- Pin 6 - Grid No.1 of Unit No.1
- Pin 7 - Heater
- PU1 - Plate of Unit No.1
- PU2 - Plate of Unit No.2

PLANE OF ELECTRODES OF EACH UNIT IS PARALLEL TO PLANE THROUGH AXIS OF TUBE AND AA'

Plate-Seal Temperature	200 max.	°C
----------------------------------	----------	----

^o without external shield.

5894



5894

TWIN BEAM POWER TUBE

Base-Seal Temperature. 180 max. °C
 Cooling: free circulation of air around the tube is required. In addition, some forced-air cooling will generally be required to prevent exceeding the specified maximum bulb temperature.

AF POWER AMPLIFIER & MODULATOR - Class B

Maximum CCS* Ratings, Absolute Values:

DC PLATE VOLTAGE	600 max.	volts
DC GRID-No.2 (SCREEN) VOLTAGE.	250 max.	volts
DC GRID-No.1 (CONTROL-GRID) VOLTAGE.	-175 max.	volts
MAX.-SIGNAL DC PLATE CURRENT*	200 max.	ma
MAX.-SIGNAL PLATE INPUT*	120 max.	watts
MAX.-SIGNAL GRID-No.2 INPUT*	7 max.	watts
PLATE DISSIPATION*	40 max.	watts
PEAK HEATER-CATHODE VOLTAGE:		
Heater negative with respect to cathode.	100 max.	volts
Heater positive with respect to cathode.	100 max.	volts

Typical CCS* Operation:

DC Plate Voltage	450	600	volts
DC Grid-No.2 Voltage [▲]	250	250	volts
DC Grid-No.1 Voltage:			
From fixed-bias source	-23	-25	volts
Peak AF Grid-No.1-to-Grid-No.1 Voltage.	53	53	volts
DC Plate Current:			
Zero-signal value.	67	35	ma
Max.-signal value.	200	168	ma
DC Grid-No.2 Current:			
Zero-signal value.	8	4	ma
Max.-signal value.	26	27	ma
DC Grid-No.1 Current:			
Max.-signal value.	2.3	1.6	ma
Effective Load Resistance (Plate to plate)	4400	8000	ohms
Max.-Signal Driving Power (Approx.) [◆]	0.2	0.2	watt
Max.-Signal Power Output (Approx.) [◆]	60	70	watts

Maximum Circuit Values:

Grid-No.1-Circuit Resistance: [▲]		
With fixed bias.	50000 max.	ohms
With cathode bias.	Not recommended	

* Averaged over any audio-frequency cycle of sine-wave form.

[▲] Preferably obtained from a separate source or from the plate-voltage supply with a voltage divider.

◆, ◆: See next page.

MAR. 1, 1955

TUBE DIVISION

TENTATIVE DATA 1

RADIO CORPORATION OF AMERICA, HARRISON, NEW JERSEY



5894

5894

TWIN BEAM POWER TUBE

PLATE-MODULATED PUSH-PULL RF POWER AMPLIFIER - Class C Telephony

Carrier conditions per tube with a max. modulation factor of 1.0

Maximum CCS* Ratings, Absolute Values:

For max. plate voltage and max. plate input above 250 Mc,
see Rating Chart I

DC PLATE VOLTAGE	450 max.	volts
DC GRID-No.2 (SCREEN) VOLTAGE.	250 max.	volts
DC GRID-No.1 (CONTROL-GRID) VOLTAGE.	-175 max.	volts
DC PLATE CURRENT	160 max.	ma
DC GRID-No.1 CURRENT	10 max.	ma
PLATE INPUT.	72 max.	watts
GRID-No.2 INPUT.	4.5 max.	watts
PLATE DISSIPATION.	27 max.	watts
PEAK HEATER-CATHODE VOLTAGE:		
Heater negative with respect to cathode.	100 max.	volts
Heater positive with respect to cathode.	100 max.	volts

Typical CCS* Operation:

	Up to 250 Mc	At 470 Mc	
DC Plate Voltage	450	380	volts
DC Grid-No.2 Voltage (Approx.) [†]	250	250	volts
<i>From an adjustable series resistor having a max. value of</i>			
DC Grid-No.1 Voltage [‡]	20000	30000	ohms
<i>From a grid-No.1 resistor of</i>			
Peak RF Grid-No.1-to-Grid-No.1 Voltage.	120	-	volts
DC Plate Current	150	160	ma
DC Grid-No.2 Current (Approx.)	16	8	ma
DC Grid-No.1 Current (Approx.)	5	4	ma

† Driver stage should be capable of supplying the specified driving power at low distortion to the No.1 grids of the class B stage. To minimize distortion, the effective resistance per grid-No.1 circuit of the class B stage should be held at a low value. For this purpose, the use of transformer coupling is recommended. In no case, however, should the total dc grid-No.1-circuit resistance exceed 50000 ohms.

‡ Obtained preferable from a separate source modulated along with the plate supply, or from the modulated plate supply through a series resistor. It is recommended that this resistor be adjustable to permit obtaining the desired operating plate current after initial tuning adjustments are completed.

* Obtained from a grid-No.1 resistor of value shown or by partial self-bias method. A combination of grid-No.1 resistor and fixed supply has the advantage not only of protecting the tube from damage through loss of excitation but also of minimizing distortion by bias-supply compensation.

* See next page.

MAR. 1, 1955

TUBE DIVISION

TENTATIVE DATA 2

RADIO CORPORATION OF AMERICA, HARRISON, NEW JERSEY

5894



5894

TWIN BEAM POWER TUBE

	Up to 250 Mc	At 470 Mc	
Driver Power			
Output (Approx.)	0.6	13	watts
Useful Power			
Output (Approx.) ^{••}	50	35	watts

Maximum Circuit Values:

Grid-No.1-Circuit Resistance[‡] 50000 max. ohms

PUSH-PULL RF POWER AMPLIFIER & OSCILLATOR - Class C Telegraphy[□]
and
PUSH-PULL RF POWER AMPLIFIER - Class C FM Telephony

Maximum CCS[®] Ratings, Absolute Values:

For max. plate voltage and max. plate input above 250 Mc,
 see Rating Chart II

DC PLATE VOLTAGE	600 max.	volts
DC GRID-No.2 (SCREEN) VOLTAGE.	250 max.	volts
DC GRID-No.1 (CONTROL-GRID) VOLTAGE.	-175 max.	volts
DC PLATE CURRENT	220 max.	ma
DC GRID-No.1 CURRENT	10 max.	ma
PLATE INPUT.	120 max.	watts
GRID-No.2 INPUT.	7 max.	watts
PLATE DISSIPATION.	40 max.	watts
PEAK HEATER-CATHODE VOLTAGE:		
Heater negative with respect to cathode.	100 max.	volts
Heater positive with respect to cathode.	100 max.	volts

Typical CCS[®] Operation:

	Up to 250 Mc	At 470 Mc	
DC Plate Voltage	600	400 500	volts
DC Grid-No.2			
Voltage (Approx.) [•]	250	250 250	volts
<i>From an adjustable series resistor having a max. value of.</i>			
DC Grid-No.1 Voltage [•]	33000	22000 47000	ohms
<i>From a grid-No.1 resistor of.</i>			
DC Grid-No.1 Voltage [•]	-80	-38 -60	volts
<i>From cathode resistor of.</i>			
DC Grid-No.1 Voltage [•]	39000	24000 30000	ohms
<i>From cathode resistor of.</i>			
DC Grid-No.1 Voltage [•]	360	180 300	ohms
Peak RF Grid-No.1-to-Grid-No.1 Voltage.	200	-	volts
DC Plate Current	200	220 200	ma

[□] Key-down conditions per tube without amplitude modulation. Amplitude modulation essentially negative may be used if the positive peak of the audio-frequency envelope does not exceed 115% of the carrier conditions.

[•], ^{••}, [‡], [•], [■]: See next page.

MAR. 1, 1955

TUBE DIVISION

TENTATIVE DATA 2.

RADIO CORPORATION OF AMERICA, HARRISON, NEW JERSEY



5894

5894

TWIN BEAM POWER TUBE

	Up to 250 Mc	At 470 Mc		
DC Grid-No.2				
Current (Approx.)	16	12	8	ma
DC Grid-No.1				
Current (Approx.)	2	3	4	ma
Driver Power				
Output (Approx.)	4	5	13	watts
Useful Power				
Output (Approx.)**	85	43	55	watts

Maximum Circuit Values:

Grid-No.1-Circuit Resistance†. 50000 max. ohms

FREQUENCY TRIPLER - Class C

Maximum CCS* Ratings, Absolute Values:For max. plate voltage and max. plate input above 250 Mc,
see Rating Chart III

DC PLATE VOLTAGE	600 max.	volts
DC GRID-No.2 (SCREEN) VOLTAGE.	250 max.	volts
DC GRID-No.1 (CONTROL-GRID) VOLTAGE.	-175 max.	volts
DC PLATE CURRENT	160 max.	ma
DC GRID-No.1 CURRENT	10 max.	ma
PLATE INPUT.	80 max.	watts
GRID-No.2 INPUT.	7 max.	watts
PLATE DISSIPATION.	40 max.	watts

PEAK HEATER-CATHODE VOLTAGE:

Heater negative with respect to cathode	100 max.	volts
Heater positive with respect to cathode	100 max.	volts

Typical CCS* Operation as Tripler:

	Up to 150 Mc	To 225 Mc	To 462 Mc	
DC Plate Voltage	400	500	400	400 volts
DC Grid-No.2 Volt- age (Approx.)*	250	250	250	220 220 volts
From an adjust- able series resistor having max. value of	16000	39000	20000	56000 56000 ohms

* Continuous Commercial Service.

* Obtained preferably from a separate source, or from the plate-supply voltage with a voltage divider, or through a series resistor. A series grid-No.2 resistor should be used only when the 5894 is used in a circuit which is not keyed. It is recommended that this resistor be adjustable to permit obtaining the desired operating plate current after initial tuning adjustments are completed.

**†: See next page.

MAR. 1, 1955

TUBE DIVISION

TENTATIVE DATA 3

RADIO CORPORATION OF AMERICA, HARRISON, NEW JERSEY



TWIN BEAM POWER TUBE

	Up to 150 Mc	To 225 Mc	To 462 Mc	
DC Grid-No.1 Voltage [■]	-150	-150	-150	-150 -175 volts
From a grid-No.1 resistor of . . .	30000	24000	50000	36000 36000 ohms
Peak RF Grid-No.1-to-Grid-No.1 Voltage.	360	360	360	- - volts
DC Plate Current . .	146	120	130	130 140 ma
DC Grid-No.2 Current (Approx.)	16	10	20	5 5 ma
DC Grid-No.1 Current (Approx.)	5	6	3	4 5 ma
Driver Power Output (Approx.)	0.9	1	0.5	4 8 watts
Useful Power Output (Approx.) ^{●●}	18	20	12	13 16 watts

Maximum Circuit Values:

Grid-No.1-Circuit Resistance[‡]. 50000 max. ohms

CHARACTERISTICS RANGE VALUES FOR EQUIPMENT DESIGN

	Note	Min.	Max.
Heater Current:			
Series connection	1	0.8	1 amp
Parallel connection	2	1.6	2 amp
Mu-Factor, Grid No.2 to Grid No.1 (Each Unit)	2,3	7	9.3
Direct Interelectrode Capacitances (Each Unit):			
Grid No.1 to plate.	4	-	0.08 μ f
Grid No.1 to cathode & grid No.3 & internal shield, grid No.2, and heater.	4	9.4	11.6 μ f
Plate to cathode & grid No.3 & internal shield, grid No.2, and heater	4	2.6	3.7 μ f

Note 1: With 12.6 volts ac on heater.

Note 2: With 6.3 volts ac on heater.

Note 3: With dc plate voltage of 600 volts, dc grid-no.2 voltage of 250 volts, and dc plate current of 40 ma.

Note 4: Without external shield.

● This value of useful power output is measured at load of output circuit.

‡ When grid No.1 is driven positive, the total dc grid-no.1-circuit resistance should not exceed the specified value of 50000 ohms. If this value is insufficient to provide adequate bias, the additional required bias must be supplied by a cathode resistor or fixed supply.

■ Obtained from a fixed supply, by grid-no.1 resistor, by cathode resistor, or by combination methods.



5894

5894

TWIN BEAM POWER TUBE

OPERATING CONSIDERATIONS

Shielding of the 5894 in rf service is required for stable operation. A convenient method of shielding is to mount the socket approximately $7/8$ " beneath a hole in the chassis plate so that when the 5894 is inserted in the socket, the internal shield (see *Dimensional Outline*) of the tube will be close to the edge of the hole and in the same plane as the chassis plate. This arrangement provides an effective shield to isolate the grid-No. 1 circuits from the plate circuits.

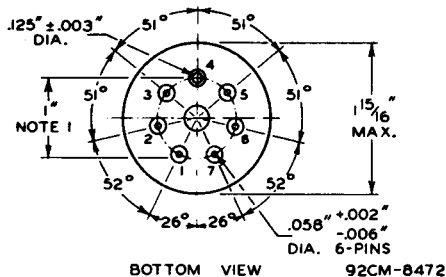
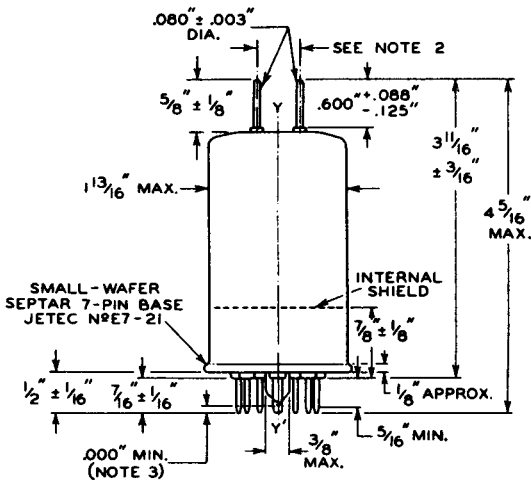

5894



5894

TWIN BEAM POWER TUBE

THE REFERENCE AXIS YY' IS DEFINED AS THE AXIS OF THE BASE-PIN GAUGE DESCRIBED IN NOTE 1.

NOTE 1: ANGULAR VARIATIONS BETWEEN PINS AND VARIATION IN PIN-CIRCLE DIAMETER ARE HELD TO TOLERANCES SUCH THAT PINS WILL ENTER TO A DISTANCE OF $3/8"$ A FLAT-PLATE BASE-PIN GAUGE HAVING SIX HOLES $0.0800" \pm 0.0005"$ AND ONE HOLE $0.1450" \pm 0.0005"$ ARRANGED ON A $1.0000" \pm 0.0005"$ CIRCLE AT SPECIFIED ANGLES WITH TOLERANCE OF $\pm 5'$ FOR EACH ANGLE. GAUGE IS ALSO PROVIDED WITH A HOLE $0.500" \pm 0.010"$ CONCENTRIC WITH PIN CIRCLE WHOSE CENTER IS ON THE AXIS YY' .

NOTE 2: THE PLATE LEADS WILL ENTER A FLAT-PLATE PLATE-LEAD GAUGE HAVING THICKNESS OF $3/8"$ AND HAVING TWO HOLES $0.1400" \pm 0.0005"$ WHOSE CENTERS ARE LOCATED AT A DISTANCE OF $0.275" \pm 0.001"$ FROM THE AXIS YY' AND WHOSE AXES ARE PARALLEL TO YY' . THE PLANE THROUGH THESE AXES WILL BE $90^\circ \pm 5'$ FROM THE PLANE THROUGH YY' AND PIN No. 4.

NOTE 3: EXHAUST TIP WILL NOT EXTEND BEYOND THE PLANE WHICH PASSES THROUGH THE ENDS OF THE THREE LONGEST PINS.



5894

RATING CHART I CLASS C TELEPHONY

5894

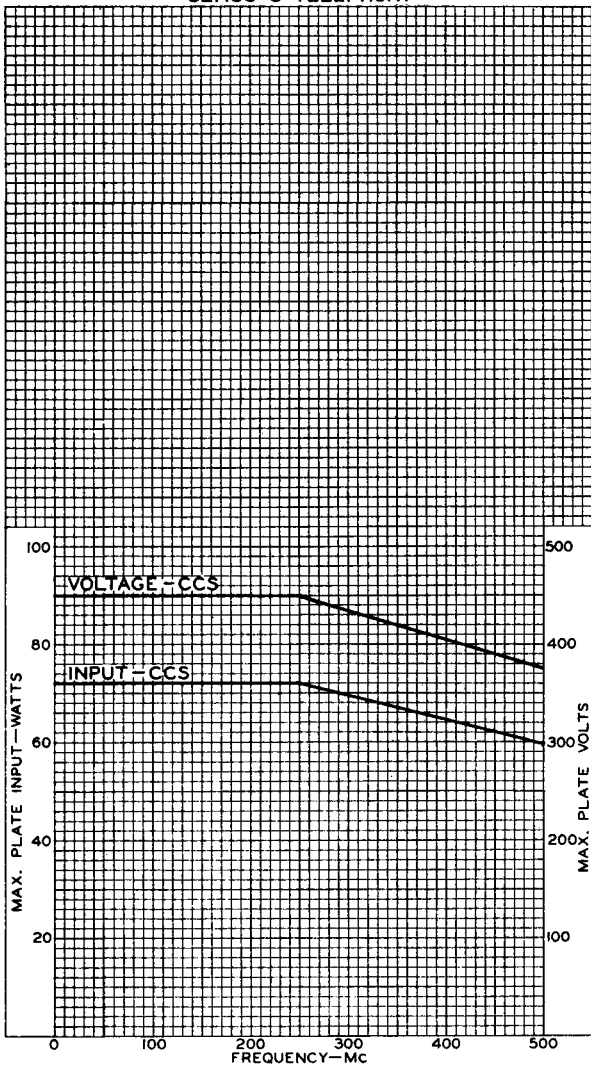

5894



5894

RATING CHART II CLASS C TELEGRAPHY

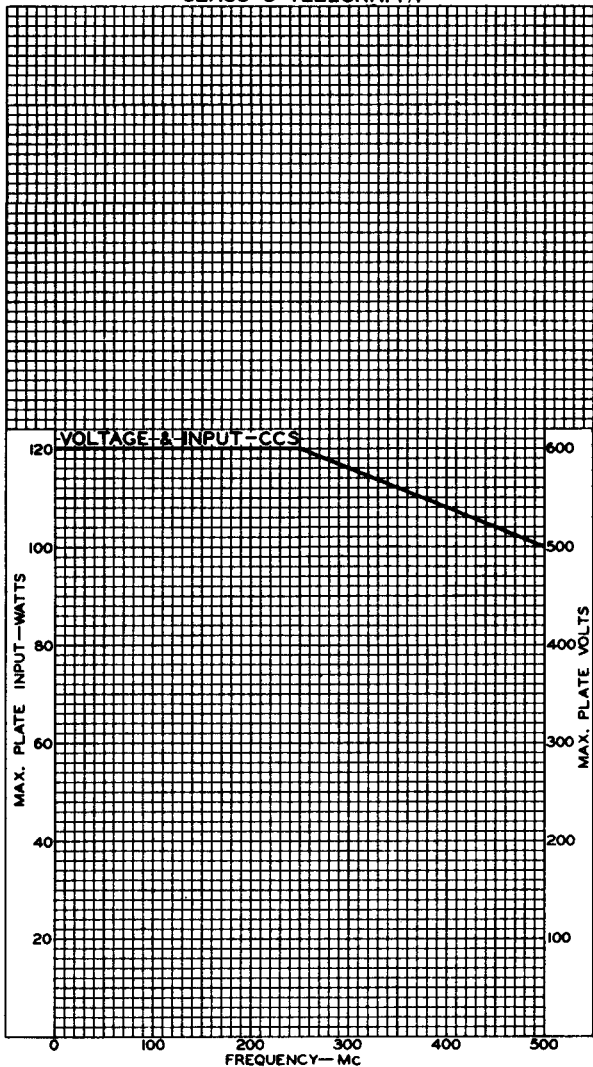



5894

RATING CHART III
CLASS C TRIPLER

5894

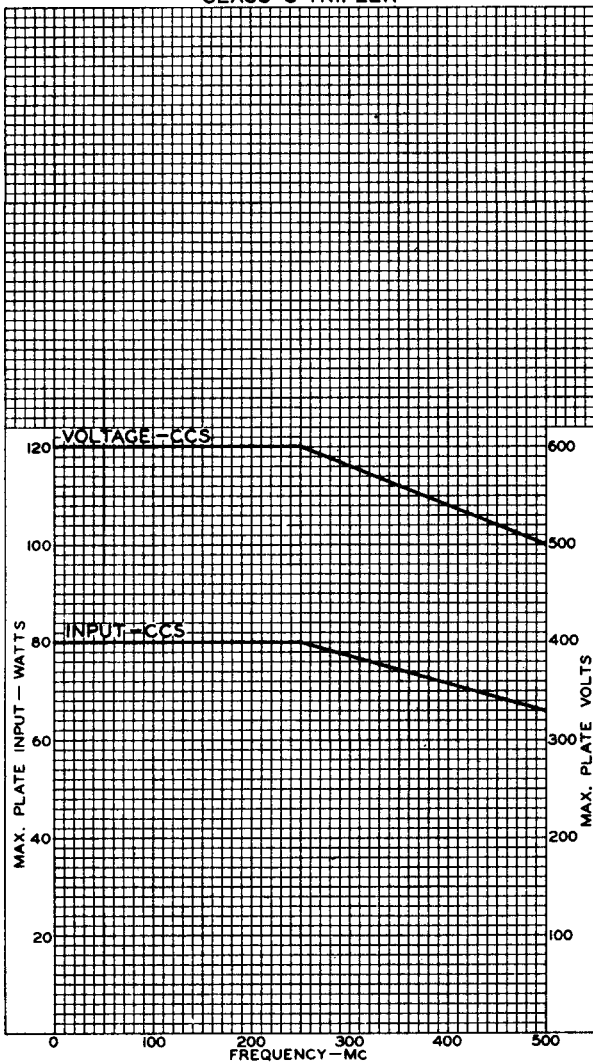

5894



5894

AVERAGE PLATE CHARACTERISTICS FOR EACH UNIT

$E_f = 12.6$ VOLTS
SERIES HEATER ARRANGEMENT
GRID - N#2 VOLTS = 200

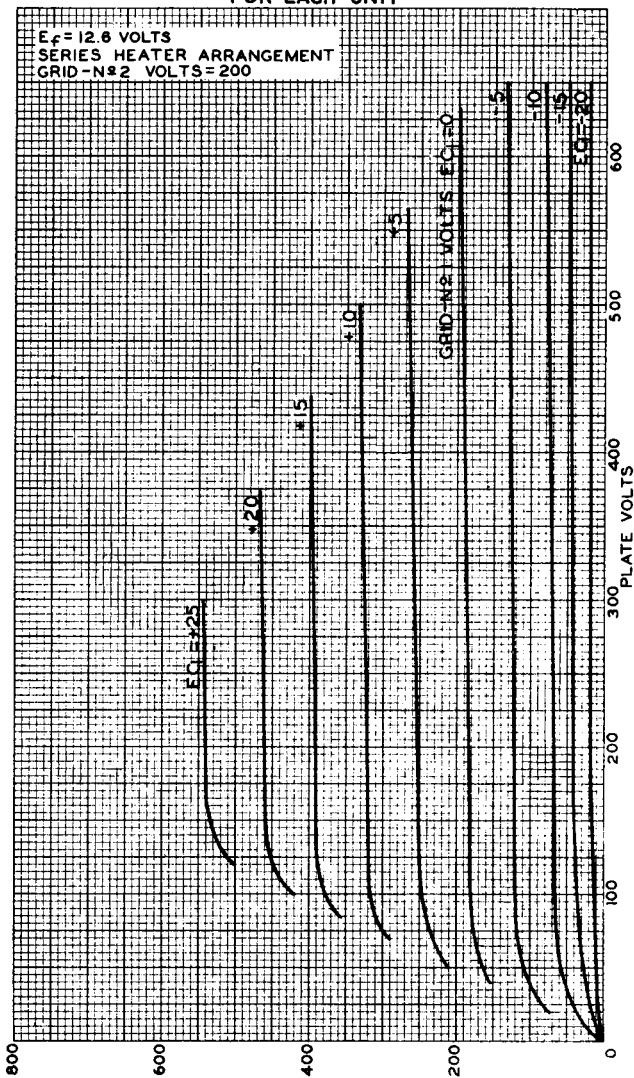

NOV. 5, 1954

PLATE MILLIAMPERES
TUBE DIVISION

92CM-8474

RADIO CORPORATION OF AMERICA, HARRISON, NEW JERSEY



5894

5894

AVERAGE CHARACTERISTICS FOR EACH UNIT

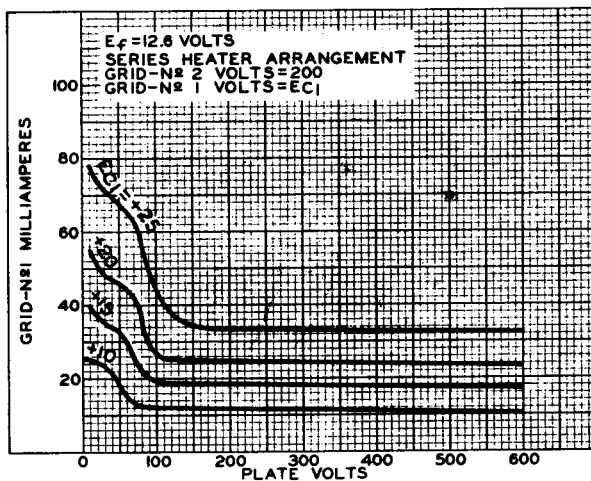
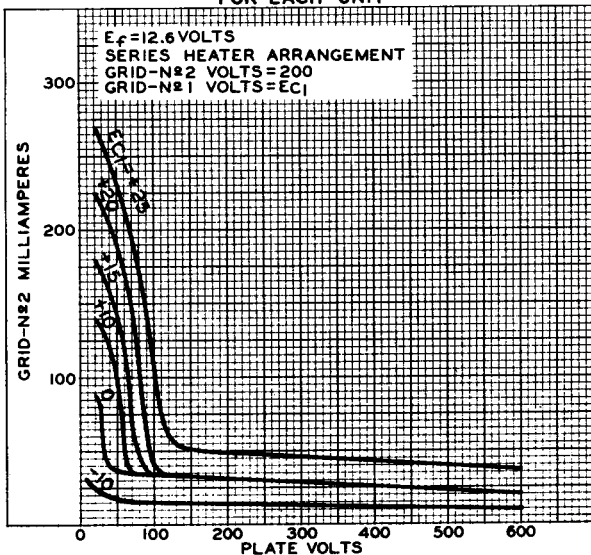

5894



5894

AVERAGE PLATE CHARACTERISTICS FOR EACH UNIT

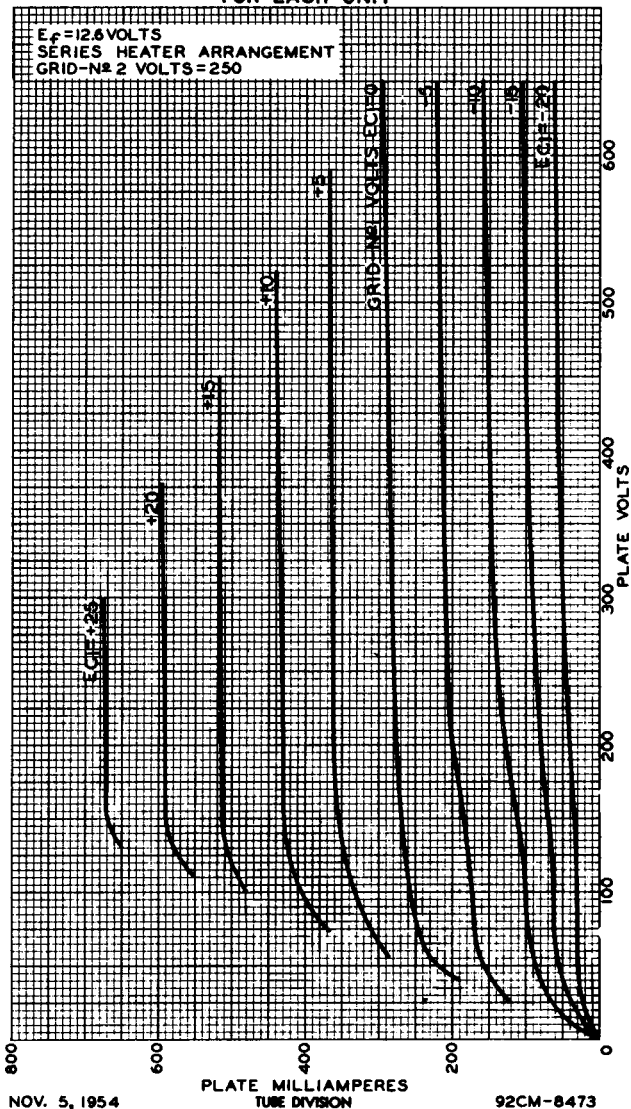

NOV. 5, 1954

92CM-8473

RADIO CORPORATION OF AMERICA, HARRISON, NEW JERSEY



5894

5894

AVERAGE CHARACTERISTICS FOR EACH UNIT

